

MDT1010CIS-LVDS	1280 x 800	LVDS Interface	TFT Module
(MCT101E0W1280800LMLIPS)			
Specification			
Version: 1	Date: 20/11/2018		
Revision			
1	06/12/2017	First issue	
2	19/11/2018	Add Uniformity	

Display Features			
Display Size	10.10"		
Resolution	1280 x 800		
Orientation	Landscape		
Appearance	RGB		
Logic Voltage	2.5V		
Interface	LVDS		
Brightness	350 cd/m ²		
Touchscreen	---		
Module Size	229.34 x 148.98 x 2.50mm		
Operating Temperature	-20°C ~ +70°C		
Pinout	40 Way Connector		
Pitch	---		
		Box Quantity	Weight / Display
		---	---

Display Accessories	
Part Number	Description

Optional Variants	
Appearances	Voltage



Summary

TFT 10.1" is a IPS transmissive type color active matrix TFT liquid crystal display . In-Plane Switching (IPS) was one of the first refinements to produce significant gains in the light-transmissive characteristics of TFT panels. It is a technology that addresses the two main issues of a standard twisted nematic (TN) TFT display: colour and viewing angle.

General Specifications

- Screen Diagonal: 10.1 inch
- Number of Pixels: 1280 x 3(RGB) x 800 dots
- Module dimension: 229.34 x 148.98 x 2.5 mm
- Active area: 216.96 (H) x 135.6(V) mm
- Pixel pitch: 0.1695 x 0.1695 mm
- Display Mode: Normally Black
- Pixel Arrangement: R.G.B. Vertical Stripe
- Backlight Type: LED, Normally White
- Aspect Ratio: 16:9
- Electrical Interface (Logic): LVDS
- With /Without TP: Without TP
- Surface: Glare

*Color tone slight changed by temperature and driving voltage.



Interface

Interface Connector

A 40pin connector is used for the module electronics interface. The recommended model is F62240-H1210B manufactured by Vigorconn.

Pin No.	Symbol	I/O	Function	Remark
1	VCOM	P	Common Voltage	
2	VDD	P	Power Supply	
3	VDD	P	Power Supply	
4	NC	-	No connection	
5	NC	-	No connection	
6	NC	-	No connection	
7	GND	P	Ground	
8	Rxin0-	I	-LVDS Differential Data Input	R0-R5,G0
9	Rxin0+	I	+LVDS Differential Data Input	
10	GND	P	Ground	
11	Rxin1-	I	-LVDS Differential Data Input	G1G5,B0,B1
12	Rxin1+	I	+LVDS Differential Data Input	
13	GND	P	Ground	
14	Rxin2-	I	-LVDS Differential Data Input	B2-B5,HS,VS, DE
15	Rxin2+	I	+LVDS Differential Data Input	
16	GND	P	Ground	
17	RxCLK-	I	-LVDS Differential Clock Input	LVDS CLK
18	RxCLK+	I	+LVDS Differential Clock Input	
19	GND	P	Ground	
20	Rxin3-	I	-LVDS Differential Data Input	R6,R7,G6,G7, B6,B7
21	Rxin3+	I	+LVDS Differential Data Input	
22	GND	P	Ground	
23	NC	-	No connection	
24	NC	-	No connection	
25	GND	P	Ground	
26	NC	-	No connection	
27	NC	-	No connection	
28	NC	-	No connection	
29	AVDD	P	Power for Analog Circuit	
30	GND	P	Ground	
31	LED-	P	LED Cathode	



32	LED-	P	LED Cathode	
33	NC	-	No connection	
34	NC	-	No connection	
35	VGL	P	Gate OFF Voltage	
36	NC	-	No connection	
37	NC	-	No connection	
38	VGH	P	Gate ON Voltage	
39	LED+	P	LED Anode	
40	LED+	P	LED Anode	

I: input, O: output, P: Power

MIDAS

design • manufacture • supply



Contour Drawing

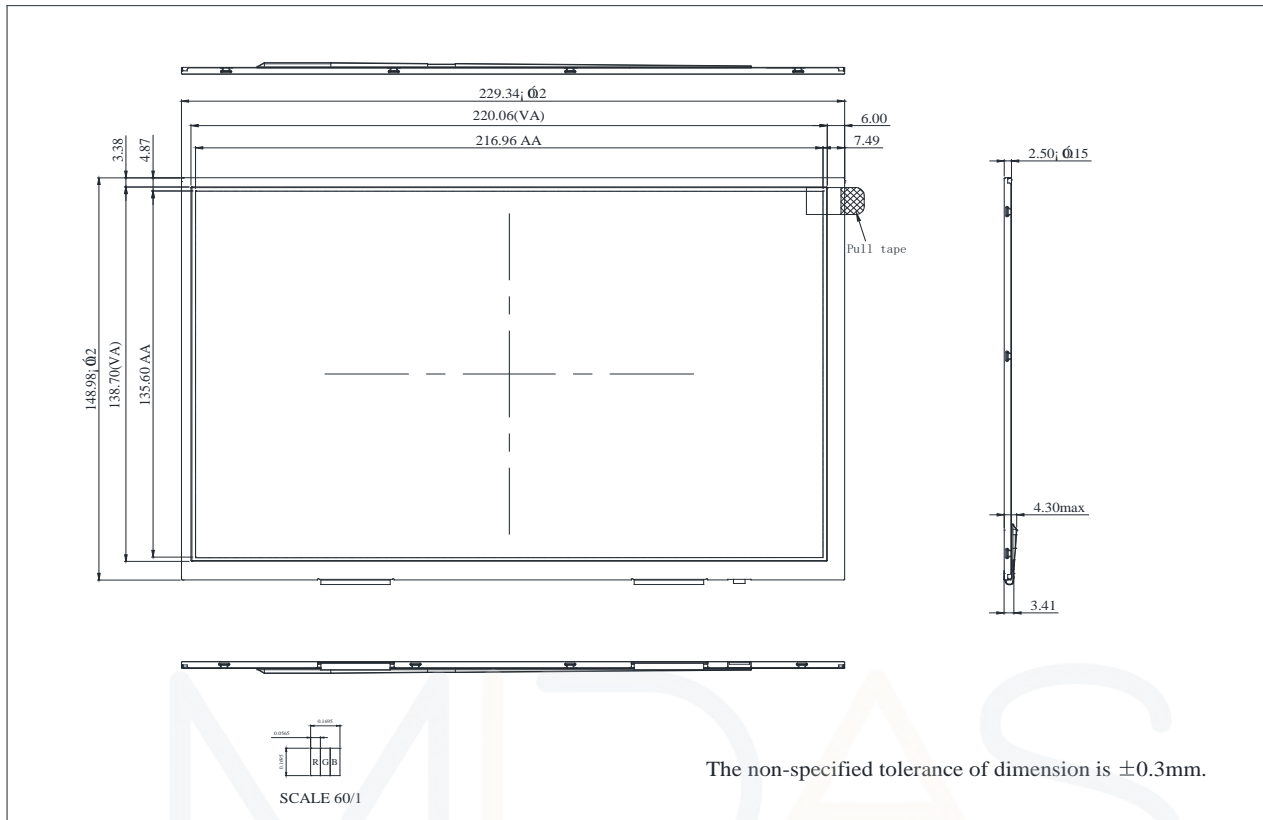

PIN NO.	SYMBOL	PIN NO.	SYMBOL
1	VCOM	21	Rxin3+
2	VDD	22	GND
3	VDD	23	NC
4	NC	24	NC
5	NC	25	GND
6	NC	26	NC
7	GND	27	NC
8	Rxin0-	28	NC
9	Rxin0+	29	AVDD
10	GND	30	GND
11	Rxin1-	31	LED-
12	Rxin1+	32	LED-
13	GND	33	NC
14	Rxin2-	34	NC
15	Rxin2+	35	VGL
16	GND	36	NC
17	RxCLK-	37	NC
18	RxCLK+	38	VGH
19	GND	39	LED+
20	Rxin3-	40	LED+

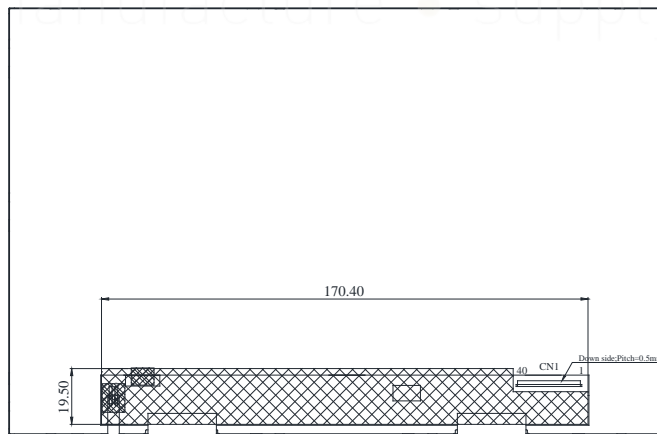

The non-specified tolerance of dimension is ±0.3mm.



Absolute Maximum Ratings

Item	Symbol	Min	Typ	Max	Unit
Operating Temperature	TOP	-20	—	+70	°C
Storage Temperature	TST	-20	—	+70	°C

Note: Device is subject to be damaged permanently if stresses beyond those absolute maximum ratings listed above

1. Temp. $\leq 60^{\circ}\text{C}$, 90% RH MAX. Temp. $> 60^{\circ}\text{C}$, Absolute humidity shall be less than 90% RH at 60°C

Electrical Characteristics

Typical Operation Conditions

(Note 1)

Item	Symbol	Values			Unit	Remark
		Min.	Typ.	MAX.		
Power voltage	VDD	2.3	2.5	2.7	V	
	AVDD	8.0	8.2	8.4	V	
	VGH	21.7	22	22.3	V	
	VGL	-7.3	-7	-6.7	V	
Input signal voltage	VCOM	2.7	3.0	3.3	V	Note 2

Note 1: Be sure to apply VDD and VGL to the LCD first, and then apply VGH.

Note 2: Typical VCOM is only a reference value, it must be optimized according to each LCM. Be sure to use VR.

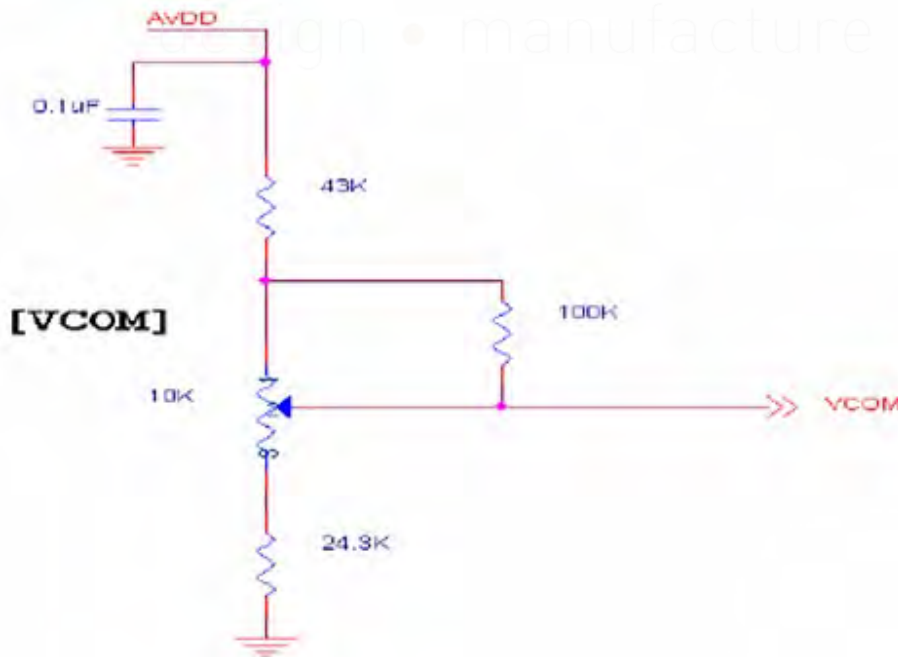

Current Consumption

Item	Symbol	Values			Unit	Remark
		Min.	Typ.	MAX.		
Current for Driver	IGH	-	705	750	uA	VGH =22V
	IGL	-	705	750	uA	VGL = -7V
	IVDD	-	95	120	mA	VDD =2.5V
	IAVDD	-	45	70	mA	AVDD=8.2V

Power Sequence

a. Power on:

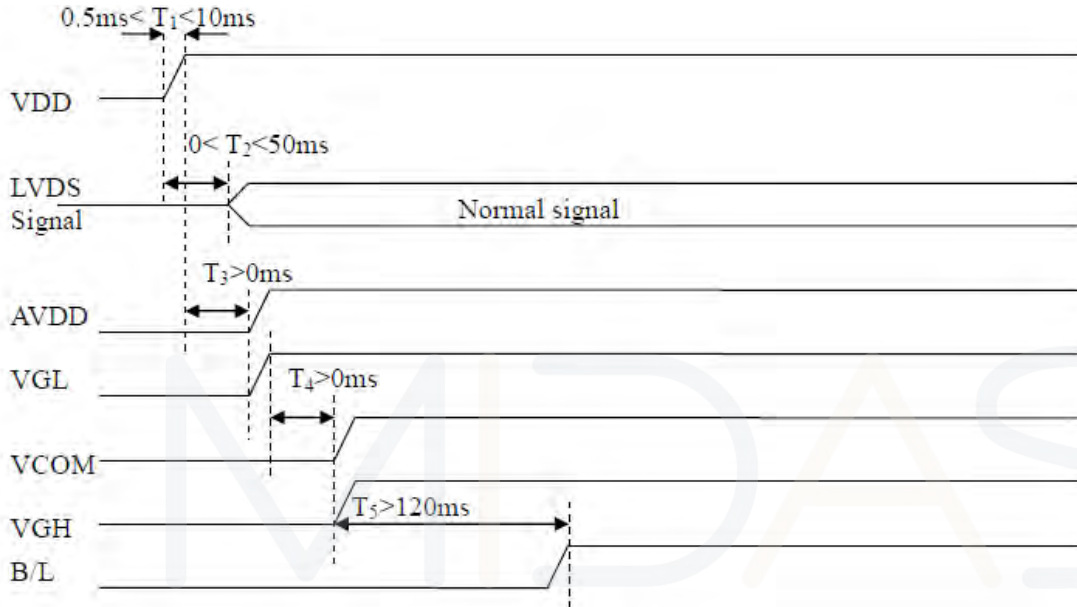

b. Power off:

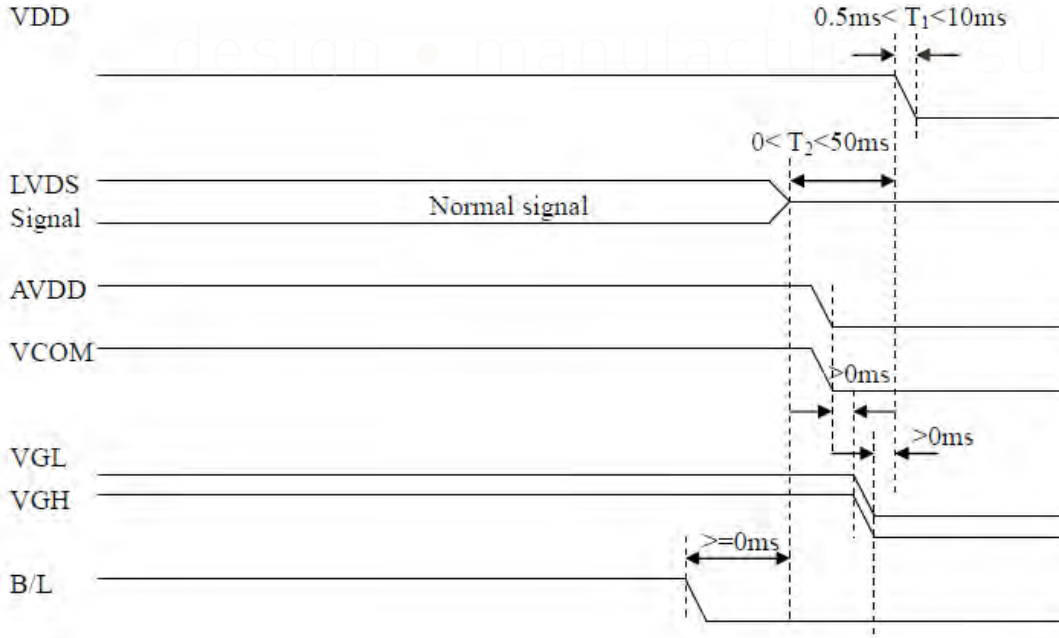

Backlight Characteristics

Parameter	Symbol	Min.	Typ.	Max.	Unit	Remark
Supply voltage of white LED backlight	VL	8.6	9.6	10.2	V	Note 1
Current for LED backlight	IL	—	220	—	mA	
LED life time	-	50000	-	-	Hr	Note 1

Note 1 : There are 1 Groups LED

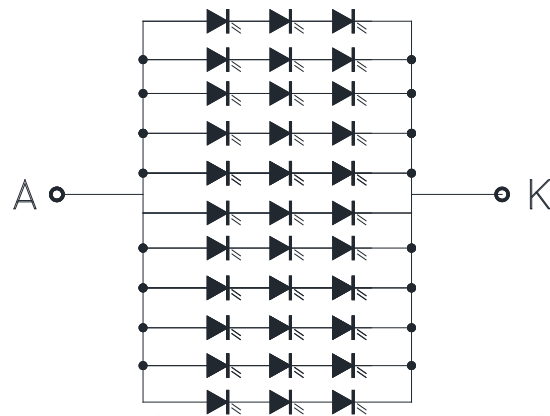

Note 2 : $T_a = 25\text{ }^\circ\text{C}$

Note 3 : Brightness to be decreased to 50% of the initial value

Note 4 : The single LED lamp case

MIDAS

design • manufacture • supply



LVDS Signal Timing Characteristics

AC Electrical Characteristics

Parameter	Symbol	Values			Unit	Remark
		Min.	Typ.	MAX.		
LVDS Differential input high Threshold voltage	RxVTH	-	-	+100	mV	RXVCM=1.2 V
LVDS Differential input low Threshold voltage	RxVTL	-100	-	-	mV	
LVDS Differential input common mode voltage	RxVCM	0.7	-	1.6	V	
LVDS Differential voltage	VID	200	-	600	mV	

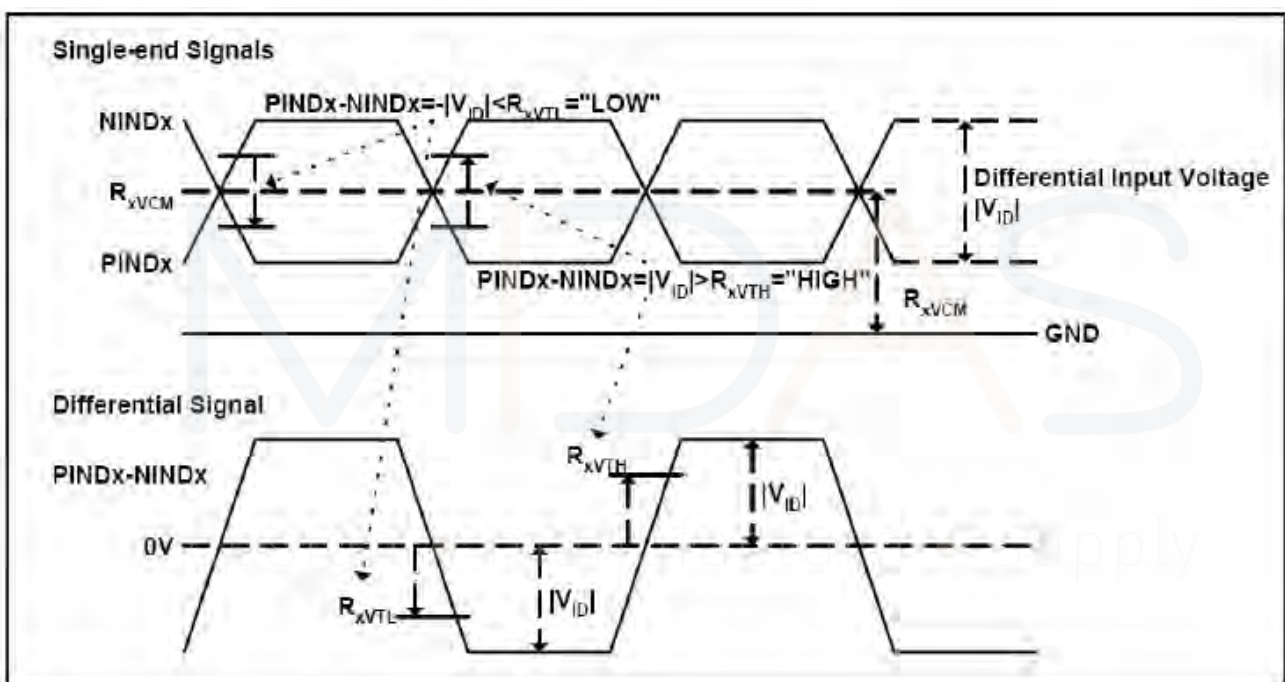

Timing Table

Parameter	Symbol	Value			Unit	Remark
		Min.	Typ.	Max.		
Clock Frequency	1/Tc	68.9	71.1	73.4	Mhz	Frame rate =60Hz
Horizontal display area	thd	1280			Tc	
HS period time	th	1410	1440	1470	Tc	
HS Width +Back Porch +Front Porch	tHW+ tHBP +tHFP	60	160	190	Tc	
Vertical display area	tvd	800			tH	
VS period time	tv	815	823	833	tH	
VS Width +Back Porch +Front Porch	tVW+ tVBP +tVFP	15	23	33	tH	

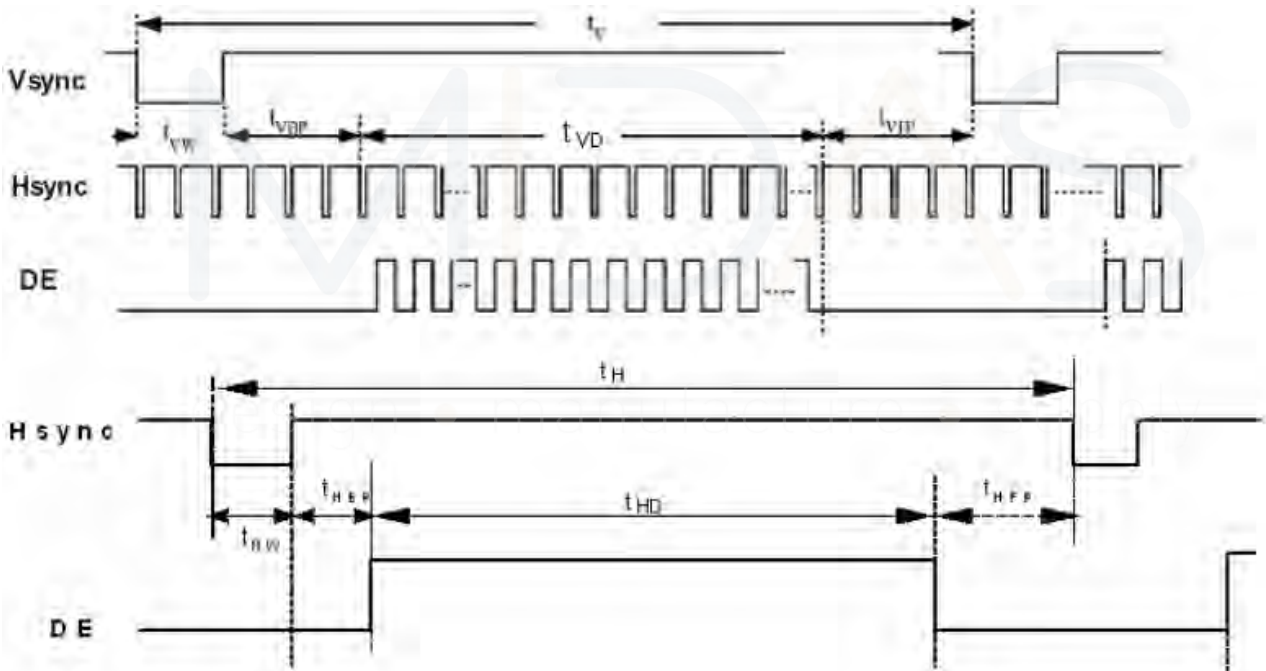

LVDS Data Input Format

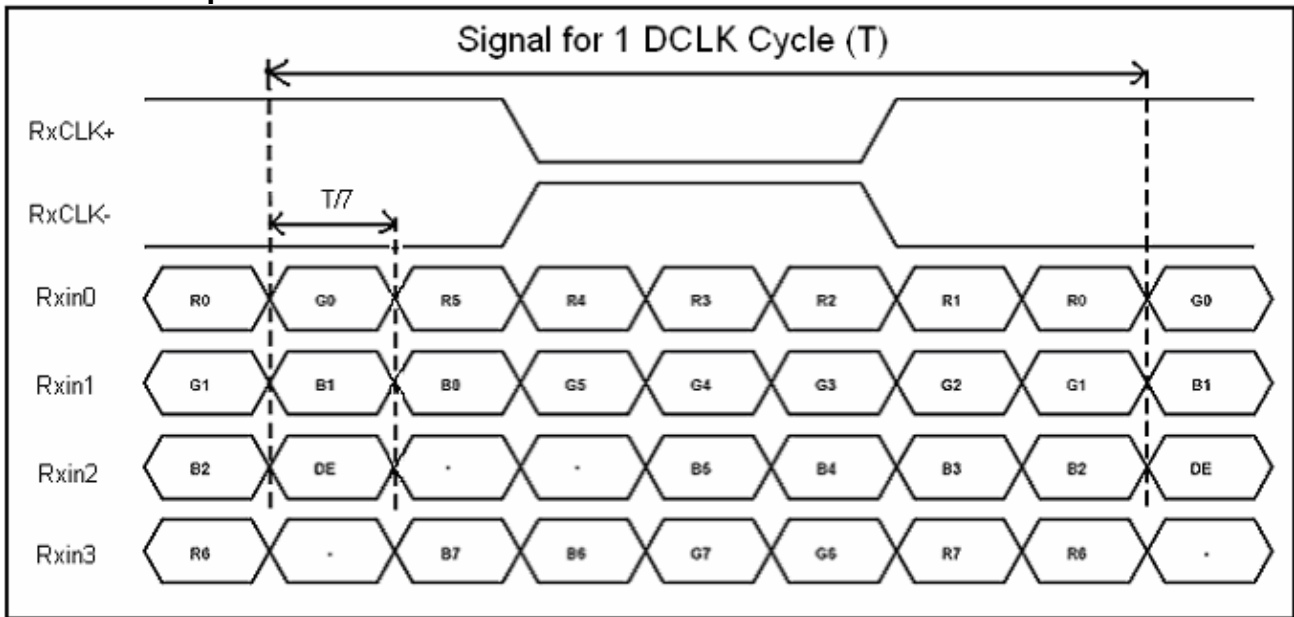

MIDAS

design • manufacture • supply



Optical Characteristics

Item	Symbol	Condition.	Min	Typ.	Max.	Unit	Remark
Response time	Tr	$\theta=0^\circ$ 、 $\Phi=0^\circ$	-	10	20	.ms	Note 3
	Tf		-	15	30		
Contrast ratio	CR	At optimized viewing angle	600	800	-	-	Note 4
Color Chromaticity	White	Wx	0.26	0.31	0.36	-	Note 2,6,7
		Wy	0.28	0.33	0.38	-	
Viewing angle (Gray Scale Inversion Direction)	Hor.	Θ_R	75	85	-	Deg.	Note 1
		Θ_L	75	85	-		
	Ver.	Φ_T	75	85	-		
		Φ_B	75	85	-		
Brightness	-	-	350	-	-	cd/m ²	Center of display
Uniformity	(U)	-	70	-	-	%	Note 5

Ta=25±2°C

Note 1: Definition of viewing angle range

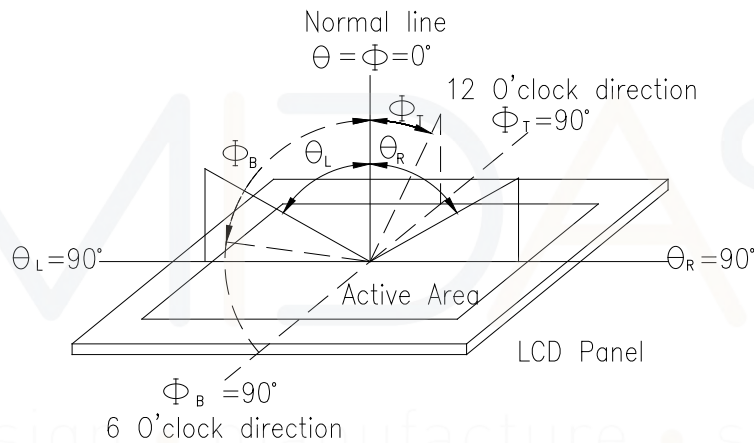

Fig. 9.1. Definition of viewing angle

Note 2: Test equipment setup:

After stabilizing and leaving the panel alone at a driven temperature for 10 minutes, the measurement should be executed. Measurement should be executed in a stable, windless, and dark room. Optical specifications are measured by Topcon BM-7 or BM-5 luminance meter 1.0° field of view at a distance of 50cm and normal direction.

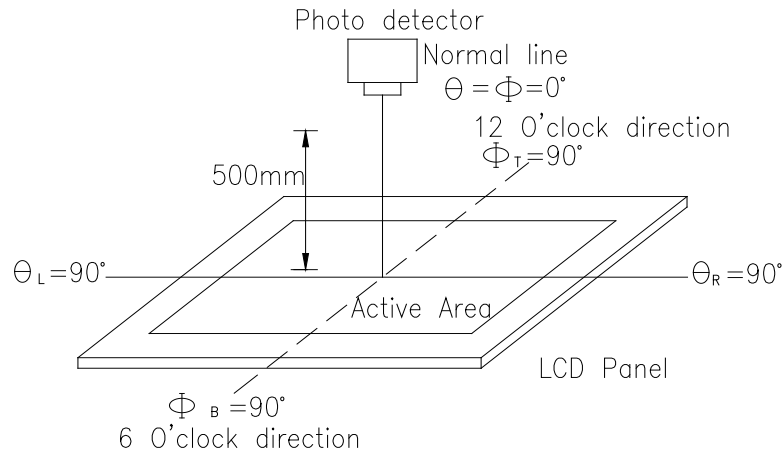
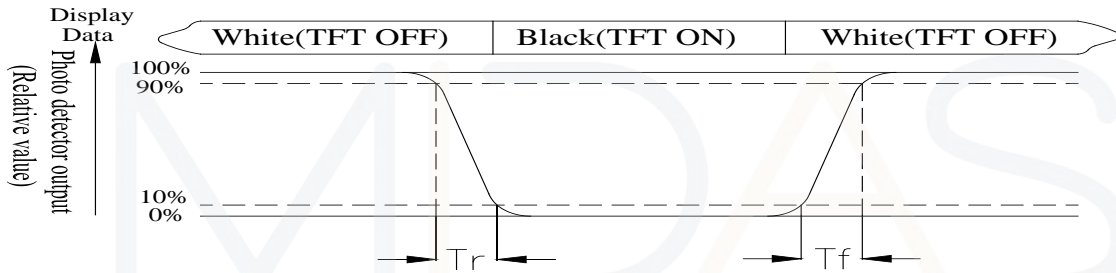

Fig. 9.2. Optical measurement system setup

Note 3: Definition of Response time:

The response time is defined as the LCD optical switching time interval between "White" state and "Black" state. Rise time, T_r , is the time between photo detector output intensity changed from 90% to 10%. And fall time, T_f , is the time between photo detector output intensity changed from 10% to 90%



Note 4: Definition of contrast ratio:

The contrast ratio is defined as the following expression.

$$\text{Contrast ratio (CR)} = \frac{\text{Luminance measured when LCD on the "White" state}}{\text{Luminance measured when LCD on the "Black" state}}$$



Note 5: Definition of Luminance Uniformity

Active area is divided into 9 measuring areas (reference the picture in below). Every measuring point is placed at the center of each measuring area.

Luminance Uniformity (U) = $L_{min}/L_{max} \times 100\%$

L = Active area length

W = Active area width

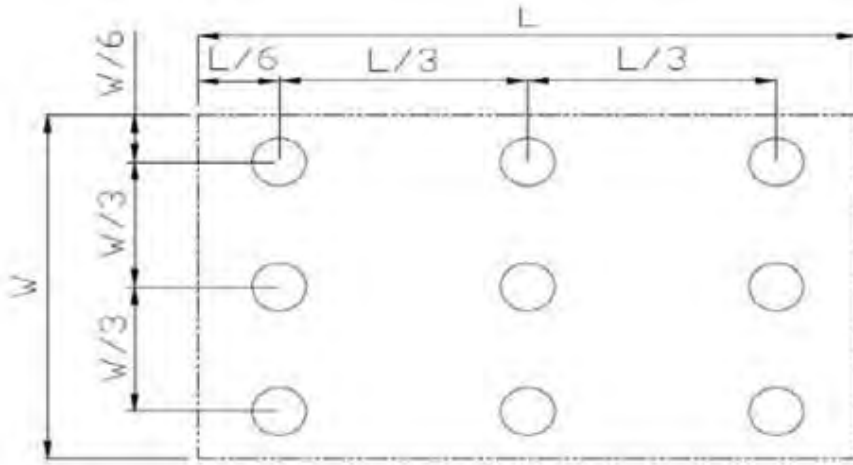

Fig9.3. Definition of uniformity

Note 6: Definition of color chromaticity (CIE 1931)

Color coordinates measured at the center point of LCD

Note 7: Measured at the center area of the panel when all the input terminals of LCD panel are electrically opened.

design • manufacture • supply



Reliability

Content of Reliability Test (Wide temperature, -20°C~70°C)

Environmental Test			
Test Item	Content of Test	Test Condition	Note
High Temperature storage	Endurance test applying the high storage temperature for a long time.	70°C 200hrs	2
Low Temperature storage	Endurance test applying the low storage temperature for a long time.	-20°C 200hrs	1,2
High Temperature Operation	Endurance test applying the electric stress (Voltage & Current) and the thermal stress to the element for a long time.	70°C 200hrs	—
Low Temperature Operation	Endurance test applying the electric stress under low temperature for a long time.	-20°C 200hrs	1
High Temperature/ Humidity Operation	The module should be allowed to stand at 60°C,90%RH max	60°C,90%RH 96hrs	1,2
Thermal shock resistance	The sample should be allowed stand the following 10 cycles of operation <div style="text-align: center;"> <p style="margin: 0;">-20°C 25°C 70°C</p> <p style="margin: 0;">30min 5min 30min</p> <p style="margin: 0;">1 cycle</p> </div>	-20°C/70°C 10 cycles	—
Vibration test	Endurance test applying the vibration during transportation and using.	Total fixed amplitude : 1.5mm Vibration Frequency : 10~55Hz One cycle 60 seconds to 3 directions of X,Y,Z for Each 15 minutes	3
Static electricity test	Endurance test applying the electric stress to the terminal.	VS=±600V(contact) , ±800v(air), RS=330Ω CS=150pF 10 times	—

Note1: No dew condensation to be observed.

Note2: The function test shall be conducted after 4 hours storage at the normal Temperature and humidity after remove from the test chamber.

Note3: The packing have to including into the vibration testing.

