

MDT1010CISC-LVDS	1280 x 800	LVDS Interface	TFT Module
(MCT101E0CW1280800LMLIPS) Specification			
Version: 2		Date: 19/06/2019	
Revision			
1	02/01/2018	First issue	
2	17/06/2019	Modify Current Consumption & Power Sequence, Modify contour drawing.	

Display Features			
Display Size	10.10"		
Resolution	1280 x 800		
Orientation	Landscape		
Appearance	RGB		
Logic Voltage	2.5V		
Interface	LVDS		
Brightness	300 cd/m ²		
Touchscreen	CTP		
Module Size	257.96 x 168.60 x 5.575mm		
Operating Temperature	-20°C ~ +70°C		
Pinout	40 Way Connector		Box Quantity
Pitch	---		Weight / Display

Display Accessories	
Part Number	Description

Optional Variants	
Appearances	Voltage



Summary

TFT 10.1" is a TN transmissive type color active matrix TFT liquid crystal display that use amorphous silicon TFT as switching devices. This module is a composed of a TFT_LCD module.

It is usually designed for industrial application and this module follows RoHs.

General Specifications

- Screen Diagonal: 10.1 inch
- Number of Pixels: 1280 x 3(RGB) x 800 dots
- Module dimension: 257.96 x 168.6 x 5.575 mm
- Active area: 216.96 (H) x 135.6(V) mm
- Pixel pitch: 0.1695 x 0.1695 mm
- Display Mode: Normally Black
- Pixel Arrangement: R.G.B. Vertical Stripe
- Backlight Type: LED, Normally White
- Aspect Ratio: 16:9
- CTP FW Version: 50
- Electrical Interface (Logic): LVDS
- With /Without TP: With CTP
- Surface: Glare

*Color tone slight changed by temperature and driving voltage.



Interface

Interface Connector

A 40pin connector is used for the module electronics interface. The recommended model is F62240-H1210B manufactured by Vigorconn.

Pin No.	Symbol	I/O	Function	Remark
1	VCOM	P	Common Voltage	
2	VDD	P	Power Supply	
3	VDD	P	Power Supply	
4	NC	-	No connection	
5	NC	-	No connection	
6	NC	-	No connection	
7	GND	P	Ground	
8	Rxin0-	I	-LVDS Differential Data Input	R0-R5,G0
9	Rxin0+	I	+LVDS Differential Data Input	
10	GND	P	Ground	
11	Rxin1-	I	-LVDS Differential Data Input	G1G5,B0,B1
12	Rxin1+	I	+LVDS Differential Data Input	
13	GND	P	Ground	
14	Rxin2-	I	-LVDS Differential Data Input	B2-B5,HS,VS,DE
15	Rxin2+	I	+LVDS Differential Data Input	
16	GND	P	Ground	
17	RxCLK-	I	-LVDS Differential Clock Input	LVDS CLK
18	RxCLK+	I	+LVDS Differential Clock Input	
19	GND	P	Ground	
20	Rxin3-	I	-LVDS Differential Data Input	R6,R7,G6,G7, B6,B7
21	Rxin3+	I	+LVDS Differential Data Input	
22	GND	P	Ground	
23	NC	-	No connection	
24	NC	-	No connection	
25	GND	P	Ground	
26	NC	-	No connection	
27	NC	-	No connection	
28	NC	-	No connection	
29	AVDD	P	Power for Analog Circuit	
30	GND	P	Ground	
31	LED-	P	LED Cathode	



32	LED-	P	LED Cathode	
33	NC	-	No connection	
34	NC	-	No connection	
35	VGL	P	Gate OFF Voltage	
36	NC	-	No connection	
37	NC	-	No connection	
38	VGH	P	Gate ON Voltage	
39	LED+	P	LED Anode	
40	LED+	P	LED Anode	

I: input, O: output, P: Power

CTP PIN Definition

Pin	Symbol	Function	Remark
1	SDA	I2C data input and output	
2	SCL	I2C clock input	
3	/RST	External Reset, Low is active	
4	/INT	External interrupt to the host	
5	VDDT	Power Supply : +3.3V	
6	VSS	Ground for analog circuit	

design • manufacture • supply



Contour Drawing

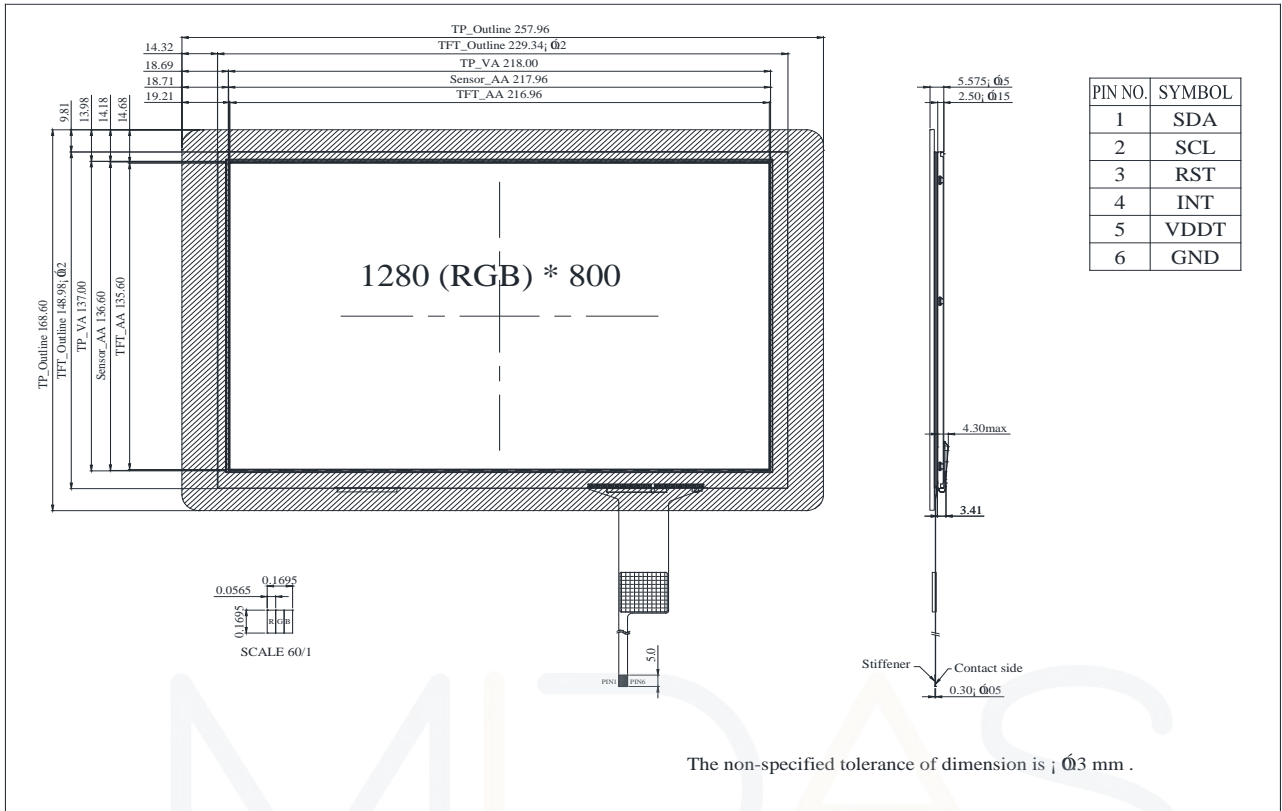

PIN NO.	SYMBOL	PIN NO.	SYMBOL
1	VCOM	21	Rxin3+
2	VDD	22	GND
3	VDD	23	NC
4	NC	24	NC
5	NC	25	GND
6	NC	26	NC
7	GND	27	NC
8	Rxin0-	28	NC
9	Rxin0+	29	AVDD
10	GND	30	GND
11	Rxin1-	31	LED-
12	Rxin1+	32	LED-
13	GND	33	NC
14	Rxin2-	34	NC
15	Rxin2+	35	VGL
16	GND	36	NC
17	RxCLK-	37	NC
18	RxCLK+	38	VGH
19	GND	39	LED+
20	Rxin3-	40	LED+

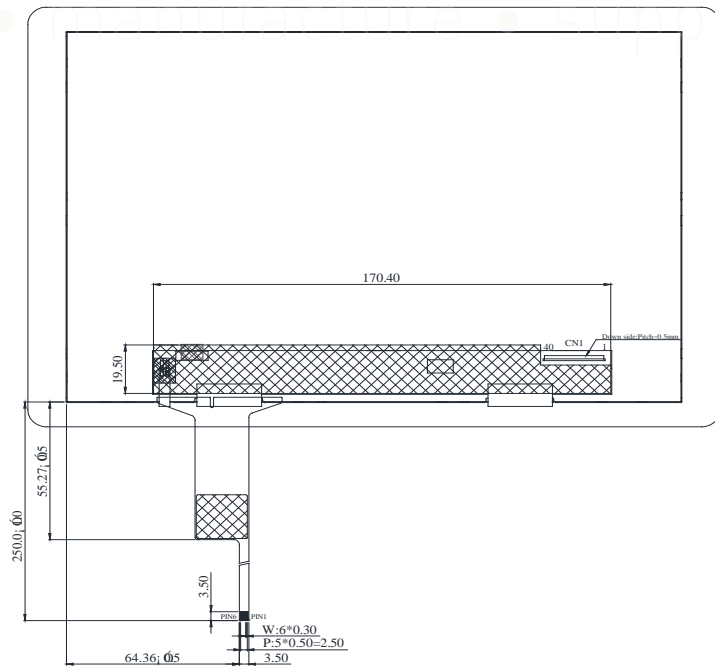

Absolute Maximum Ratings

Item	Symbol	Min	Typ	Max	Unit
Operating Temperature	TOP	-20	—	+70	°C
Storage Temperature	TST	-20	—	+70	°C

Note: Device is subject to be damaged permanently if stresses beyond those absolute maximum ratings listed above

1. Temp. $\leq 60^{\circ}\text{C}$, 90% RH MAX. Temp. $> 60^{\circ}\text{C}$, Absolute humidity shall be less than 90% RH at 60°C

Electrical Characteristics

1. Typical Operation Conditions

(Note 1)

Item	Symbol	Values			Unit	Remark
		Min.	Typ.	MAX.		
Power voltage	VDD	2.3	2.5	2.7	V	
	AVDD	8.0	8.2	8.4	V	
	VGH	21.7	22	22.3	V	
	VGL	-7.3	-7	-6.7	V	
Input signal voltage	VCOM	2.7	3.0	3.3	V	Note 2
Supply Voltage For Touch Logic	VDDT	2.8	—	3.3	V	

Note 1: Be sure to apply VDD and VGL to the LCD first, and then apply VGH.

Note 2: Typical VCOM is only a reference value, it must be optimized according to each LCM. Be sure to use VR.

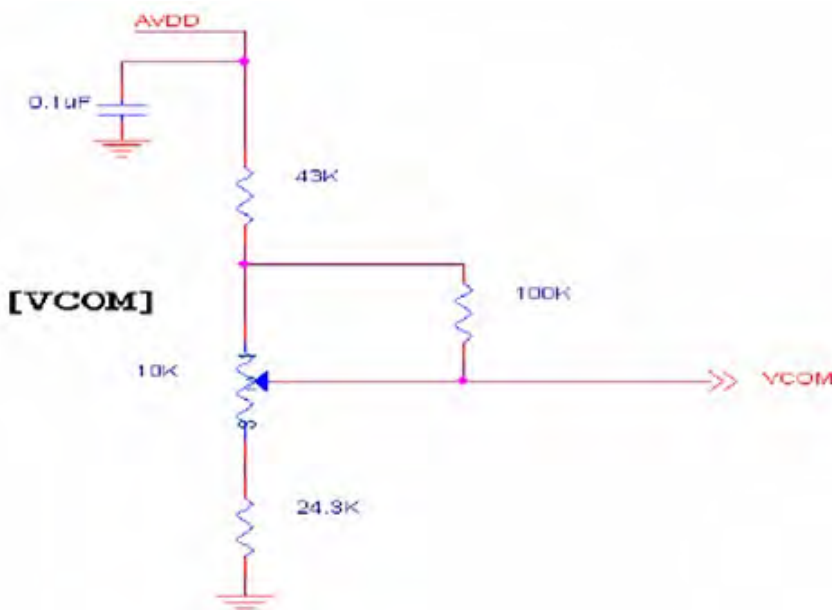

Current Consumption

Item	Symbol	Values			Unit	Remark
		Min.	Typ.	MAX.		
Current for Driver	IGH	300	705	1000	uA	VGH =22V
	IGL	300	705	1000	uA	VGL = -7V
	IVDD	50	95	120	mA	VDD =2.5V
	IAVDD	8	45	70	mA	AVDD=8.2V

Power Sequence a.

Power on:

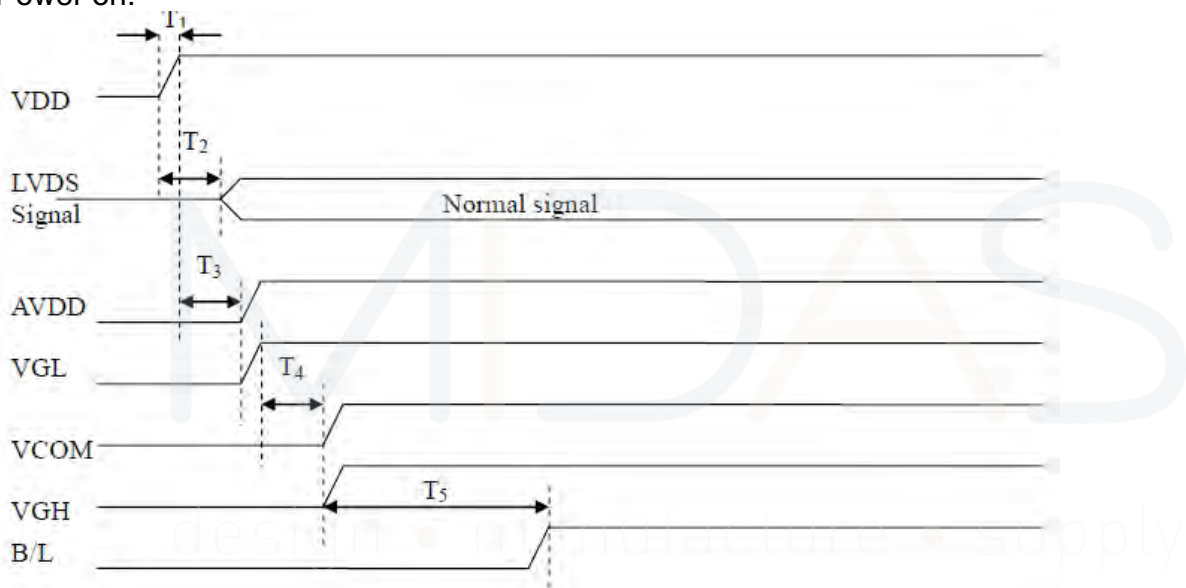

Item	Values			Unit
	Min.	Typ.	MAX.	
T1	0.5	2	10	ms
T2	0	5	50	ms
T3	0	5	50	ms
T4	0	6	100	ms
T5	120	130	200	ms

b. Power off:

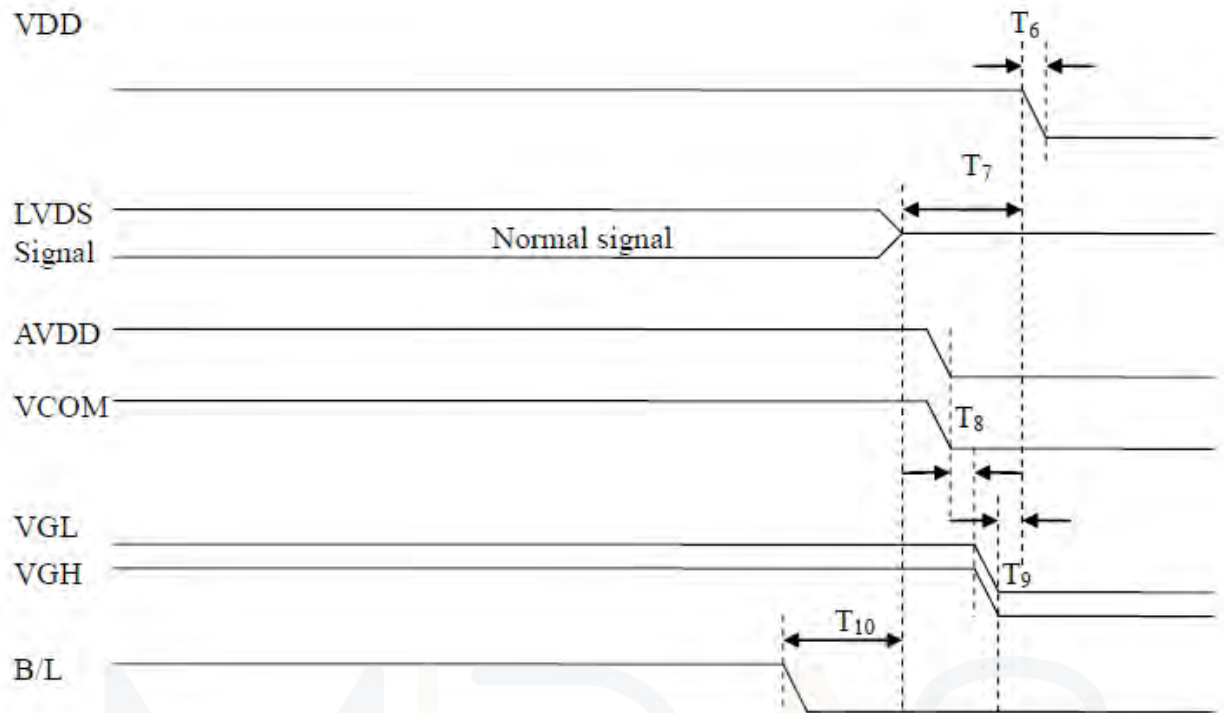

Item	Values			Unit
	Min.	Typ.	MAX.	
T6	0.5	2	10	ms
T7	0	7	50	ms
T8	0	5	10	ms
T9	0	1	10	ms
T10	0	2	100	ms



Backlight Characteristics

Parameter	Symbol	Min.	Typ.	Max.	Unit	Remark
Supply voltage of white LED backlight	VL	8.6	9.6	10.2	V	Note 1
Current for LED backlight	IL	—	220	—	mA	
LED life time	-	50000	-	-	Hr	Note 1

Note 1 : There are 1 Groups LED

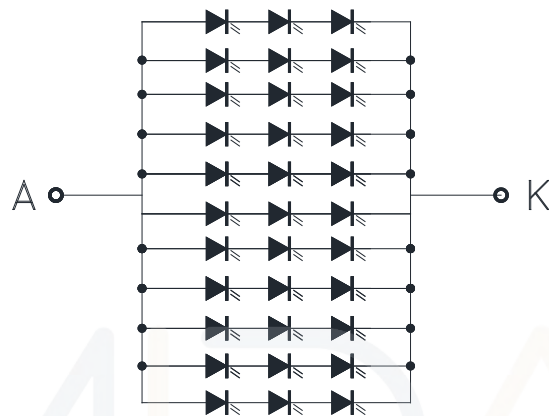

Note 2 : $T_a = 25\text{ }^\circ\text{C}$

Note 3 : Brightness to be decreased to 50% of the initial value

Note 4 : The single LED lamp case

design • manufacture • supply



LVDS Signal Timing Characteristics

AC Electrical Characteristics

Parameter	Symbol	Values			Unit	Remark
		Min.	Typ.	MAX.		
LVDS Differential input high Threshold voltage	RxVTH	-	-	+100	mV	RXVCM=1.2 V
LVDS Differential input low Threshold voltage	RxVTL	-100	-	-	mV	
LVDS Differential input common mode voltage	RxVCM	0.7	-	1.6	V	
LVDS Differential voltage	VID	200	-	600	mV	

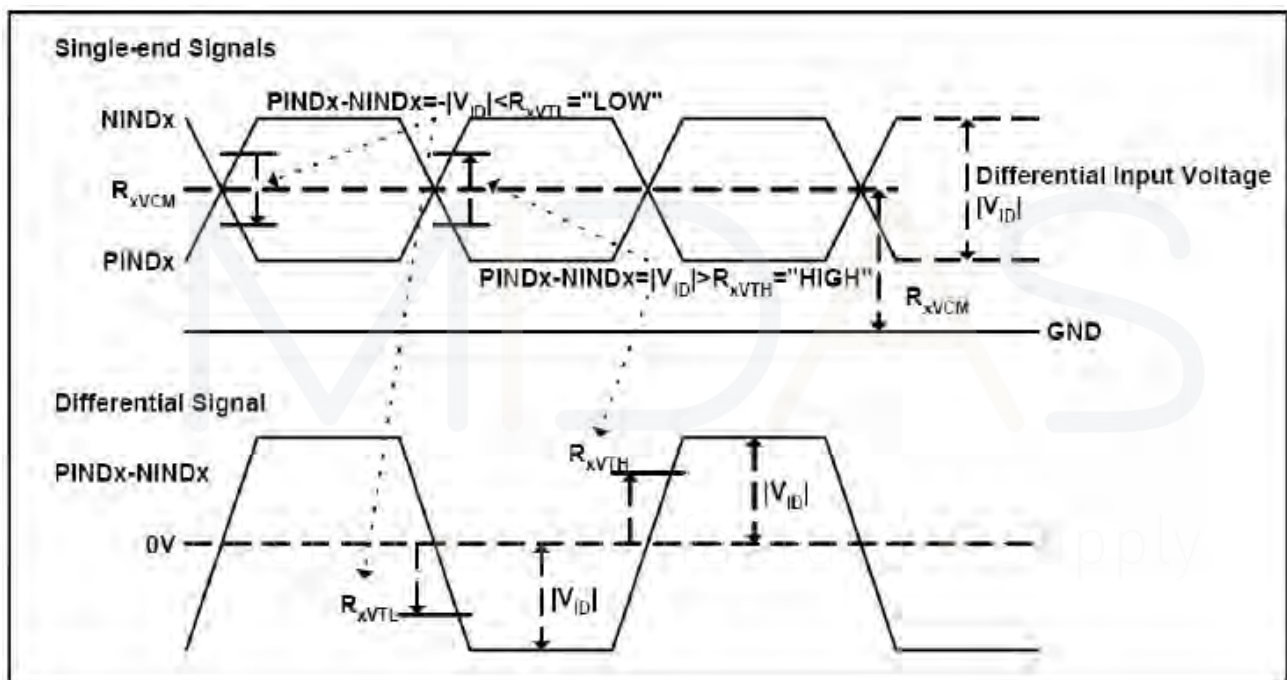

Timing Table

Parameter	Symbol	Value			Unit	Remark
		Min.	Typ.	Max.		
Clock Frequency	1/Tc	68.9	71.1	73.4	Mhz	Frame rate =60Hz
Horizontal display area	thd	1280			Tc	
HS period time	th	1410	1440	1470	Tc	
HS Width +Back Porch +Front Porch	t _{HW} + t _{HBP} +t _{HFP}	60	160	190	Tc	
Vertical display area	tvd	800			tH	
VS period time	tv	815	823	833	tH	
VS Width +Back Porch +Front Porch	t _{VW} + t _{VBP} +t _{VFP}	15	23	33	tH	

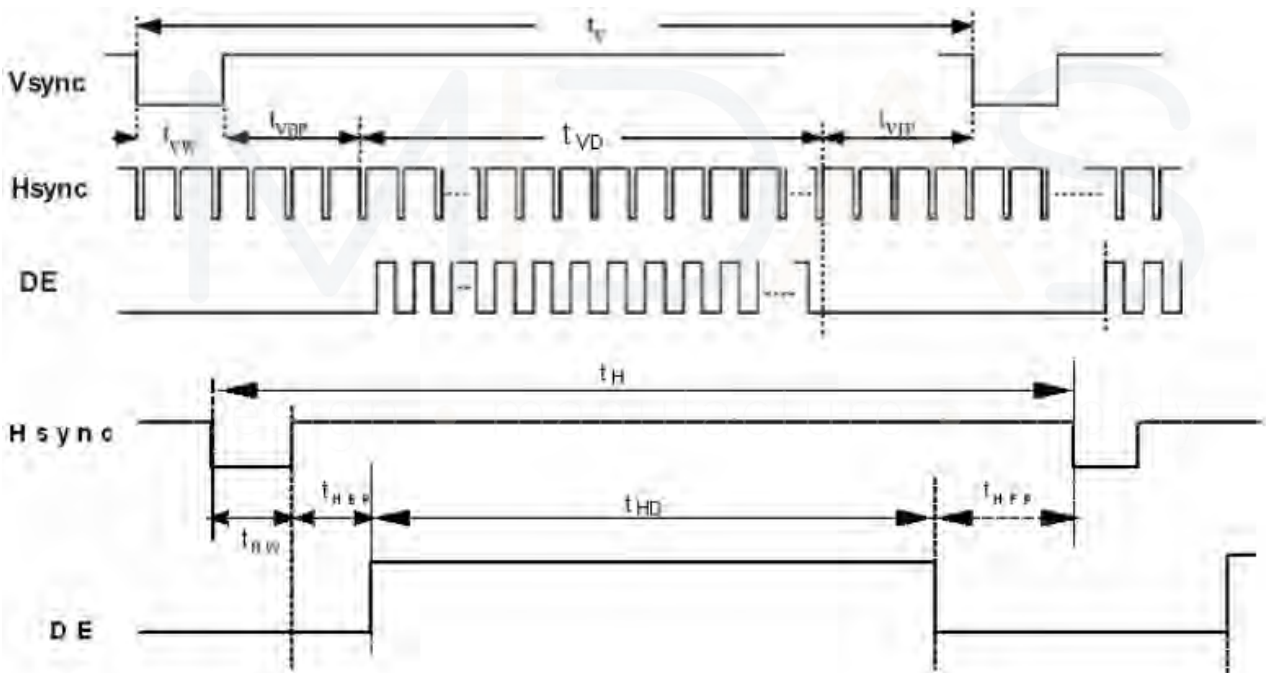

LVDS Data Input Format

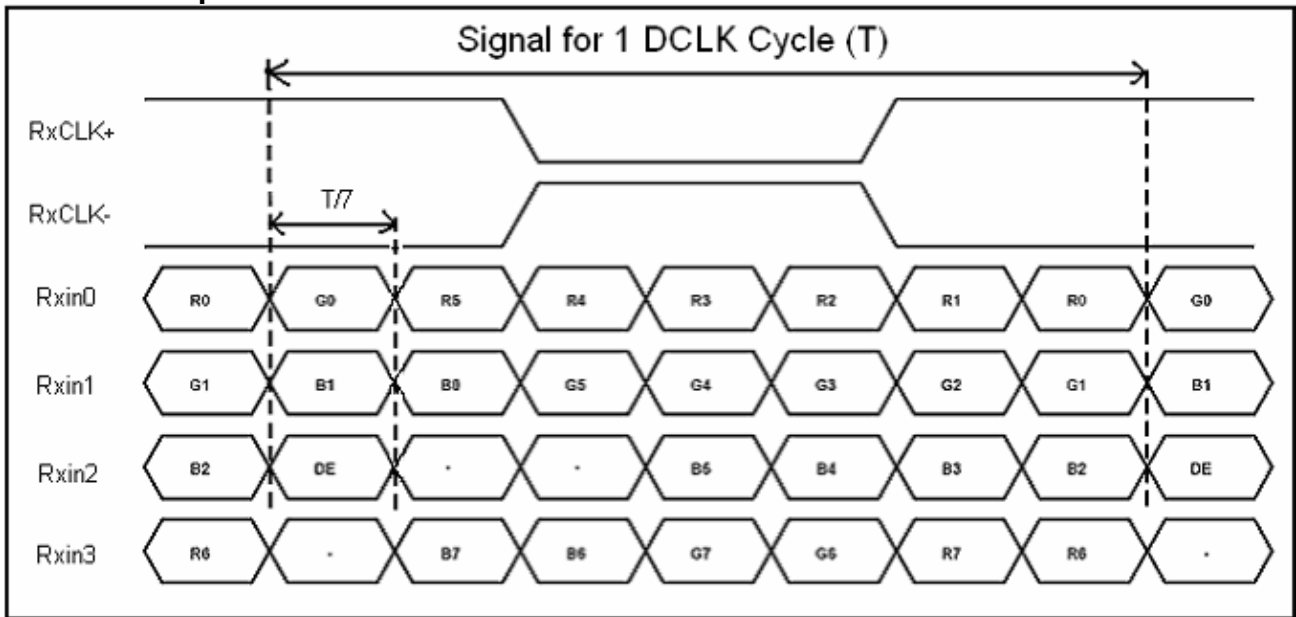

MIDAS

design • manufacture • supply



Optical Characteristics

Item	Symbol	Condition.	Min	Typ.	Max.	Unit	Remark
Response time	Tr	$\theta=0^\circ$ 、 $\phi=0^\circ$	-	10	20	.ms	Note 3
	Tf		-	15	30		
Contrast ratio	CR	At optimized viewing angle	600	800	-	-	Note 4
Color Chromaticity	White	Wx	0.26	0.31	0.36	-	Note 2,6,7
		Wy	0.28	0.33	0.38	-	
Viewing angle (Gray Scale Inversion Direction)	Hor.	Θ_R	75	85	-	Deg.	Note 1
		Θ_L	75	85	-		
	Ver.	Φ_T	75	85	-		
		Φ_B	75	85	-		
Brightness	-	-	300	-	-	cd/m ²	Center of display
Uniformity	(U)	-	70	-	-	%	Note 5

Ta=25±2°C

Note 1: Definition of viewing angle range

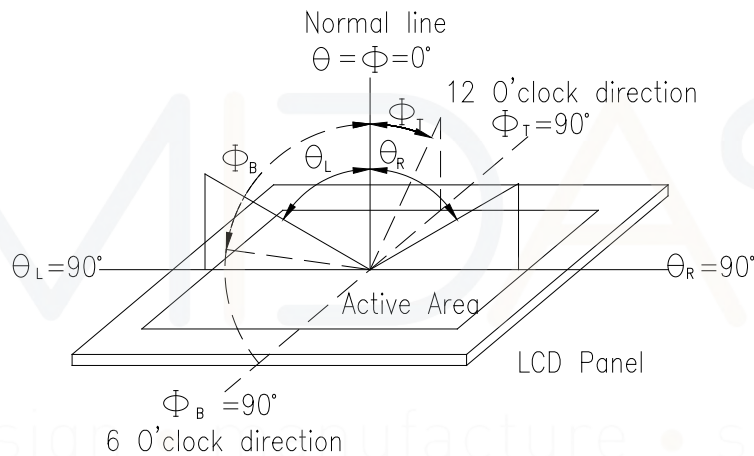

Fig. 9.1. Definition of viewing angle

Note 2: Test equipment setup:

After stabilizing and leaving the panel alone at a driven temperature for 10 minutes, the measurement should be executed. Measurement should be executed in a stable, windless, and dark room. Optical specifications are measured by Topcon BM-7 or BM-5 luminance meter 1.0° field of view at a distance of 50cm and normal direction.

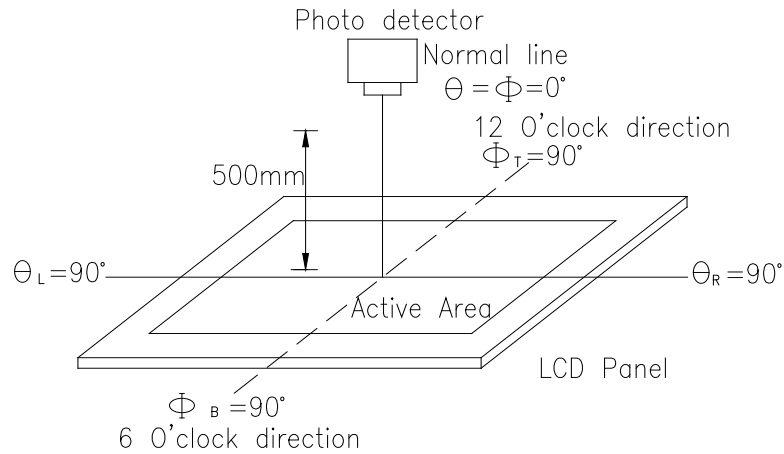
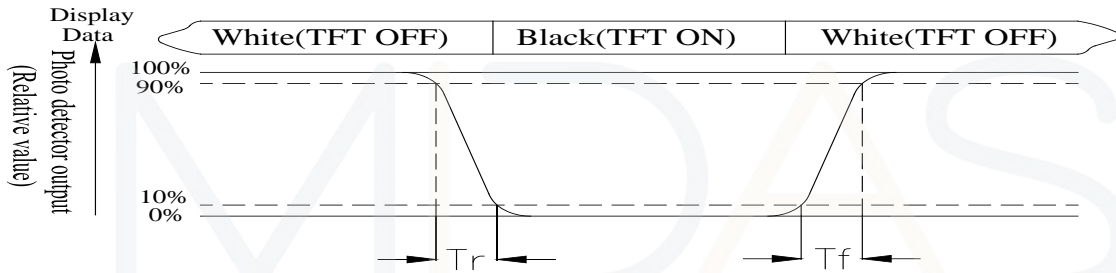

Fig. 9.2. Optical measurement system setup

Note 3: Definition of Response time:

The response time is defined as the LCD optical switching time interval between "White" state and "Black" state. Rise time, T_r , is the time between photo detector output intensity changed from 90% to 10%. And fall time, T_f , is the time between photo detector output intensity changed from 10% to 90%



Note 4: Definition of contrast ratio:

The contrast ratio is defined as the following expression.

$$\text{Contrast ratio (CR)} = \frac{\text{Luminance measured when LCD on the "White" state}}{\text{Luminance measured when LCD on the "Black" state}}$$



Note 5: Definition of Luminance Uniformity

Active area is divided into 9 measuring areas (reference the picture in below). Every measuring point is placed at the center of each measuring area.

Luminance Uniformity (U) = $L_{min}/L_{max} \times 100\%$

L = Active area length

W = Active area width

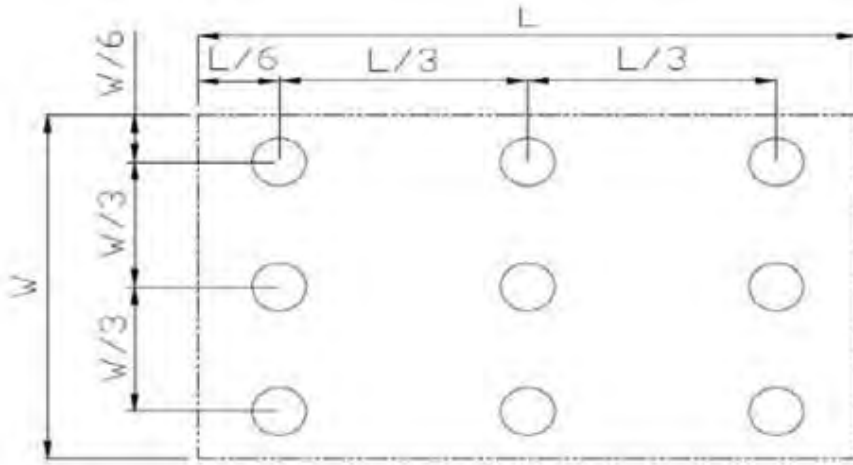

Fig9.3. Definition of uniformity

Note 6: Definition of color chromaticity (CIE 1931)

Color coordinates measured at the center point of LCD

Note 7: Measured at the center area of the panel when all the input terminals of LCD panel are electrically opened.

design • manufacture • supply



Reliability

Content of Reliability Test (Wide temperature, -20°C~70°C)

Environmental Test			
Test Item	Content of Test	Test Condition	Note
High Temperature storage	Endurance test applying the high storage temperature for a long time.	70°C 200hrs	2
Low Temperature storage	Endurance test applying the low storage temperature for a long time.	-20°C 200hrs	1,2
High Temperature Operation	Endurance test applying the electric stress (Voltage & Current) and the thermal stress to the element for a long time.	70°C 200hrs	—
Low Temperature Operation	Endurance test applying the electric stress under low temperature for a long time.	-20°C 200hrs	1
High Temperature/ Humidity Operation	The module should be allowed to stand at 60°C,90%RH max	60°C,90%RH 96hrs	1,2
Thermal shock resistance	The sample should be allowed stand the following 10 cycles of operation <div style="text-align: center;"> <p style="margin: 0;">-20°C 25°C 70°C</p> <p style="margin: 0;">30min 5min 30min</p> <p style="margin: 0;">1 cycle</p> </div>	-20°C/70°C 10 cycles	—
Vibration test	Endurance test applying the vibration during transportation and using.	Total fixed amplitude : 1.5mm Vibration Frequency : 10~55Hz One cycle 60 seconds to 3 directions of X,Y,Z for Each 15 minutes	3
Static electricity test	Endurance test applying the electric stress to the terminal.	VS=±600V(contact) , ±800v(air), RS=330Ω CS=150pF 10 times	—

Note1: No dew condensation to be observed.

Note2: The function test shall be conducted after 4 hours storage at the normal Temperature and humidity after remove from the test chamber.

Note3: The packing have to including into the vibration testing.



Timing for Read Operation

First, set address pointer based on the aforesaid Write Operation timing sequence. Then, resend Start condition to perform Read addressing and read data in the registers.

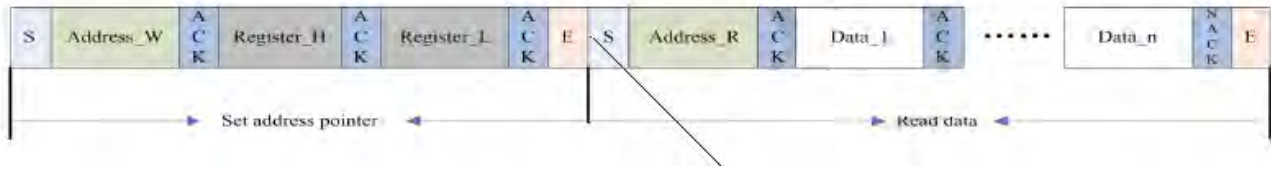

Address_R: Slave address with Read control bit.

NACK: Host issues NACK after reading the last byte.

After setting Read addresses, the host can read one or more than one byte at a time. GT9110 will automatically increase the address pointer and send subsequent data in sequence.

The Stop condition (the first E signal as shown in the above diagram) after setting the address pointer is optional. However, the repeated Start condition has to be sent.

Coordinate registers

Addr	Access	bit7	bit6	bit5	bit4	bit3	bit2	bit1	bit0
0x8140	R	Product ID(first Byte, ASCII)							
0x8141	R	Product ID(second Byte, ASCII)							
0x8142	R	Product ID(third Byte, ASCII)							
0x8143	R	Product ID(forth Byte, ASCII)							
0x8144	R	Firmware version(HEX.low byte)							
0x8145	R	Firmware version (HEX.high byte)							
0x8146	R	x coordinate resolution (low byte)							
0x8147	R	x coordinate resolution (high byte)							
0x8148	R	y coordinate resolution (low byte)							
0x8149	R	y coordinate resolution (high byte)							



0x814A	R	Vendor_id(ID of the current module)				
0x814B	R	Reserved				
0x814C	R	Reserved				
0x814D	R	Reserved				
0x814E	R/W	buffer status	large detect	Reserved	HaveKey	number of touch points
0x814F	R	track id as 32 indicates HotKnot proximity detection signal				
0x8150	R	PxyOk	Reserved			
0x8151	R	PxyOk	Reserved			
0x8152	R	Reserved				
0x8153	R	Reserved				
0x8154	R	Reserved				
0x8155	R	Reserved				
0x8156	R	Reserved				
0x8157	R	pen_sta	Reserved			track id
0x8158	R	point 1 x coordinate (low byte)				
0x8159	R	point 1 x coordinate (high byte)				
0x815A	R	point 1 y coordinate (low byte)				
0x815B	R	point 1 y coordinate (high byte)				
0x815C	R	Point 1 size (low byte)				
0x815D	R	point 1 size (high byte)				
0x815E	R	Reserved				
0x815F	R	track id				
0x8160	R	point 2 x coordinate (low byte)				
0x8161	R	point 2 x coordinate (high byte)				
0x8162	R	point 2 y coordinate (low byte)				
0x8163	R	point 2 y coordinate (high byte)				
0x8164	R	point 2 size (low byte)				
0x8165	R	point 2 size (high byte)				
0x8166	R	Reserved				
0x8167	R	track id				
0x8168	R	point 3 x coordinate (low byte)				
0x8169	R	point 3 x coordinate (high byte)				
0x816A	R	point 3 y coordinate (low byte)				
0x816B	R	point 3 y coordinate (high byte)				
0x816C	R	point 3 size (low byte)				
0x816D	R	point 3 size (high byte)				
0x816F	R	track id				
0x8170	R	point 4 x coordinate (low byte)				
0x8171	R	point 4 x coordinate (high byte)				
0x8172	R	point 4 y coordinate (low byte)				



0x8173	R	point 4 y coordinate (high byte)
0x8174	R	point 4 size (low byte)
0x8175	R	point 4 size (high byte)
0x8176	R	Reserved
0x8177	R	track id
0x8178	R	point 5 x coordinate (low byte)
0x8179	R	point 5 x coordinate (high byte)
0x817A	R	point 5 y coordinate (low byte)
0x817B	R	point 5 y coordinate (high byte)
0x817C	R	point 5 size (low byte)
0x817D	R	point 5 size (high byte)
0x817E	R	Reserved
0x817F	R	track id
0x8180	R	point 6 x coordinate (low byte)
0x8181	R	point 6 x coordinate (high byte)
0x8182	R	point 6 y coordinate (low byte)
0x8183	R	point 6 y coordinate (high byte)
0x8184	R	point 6 size (low byte)
0x8185	R	point 6 size (high byte)
0x8186	R	Reserved
0x8187	R	track id
0x8188	R	point 7 x coordinate (low byte)
0x8189	R	point 7 x coordinate (high byte)
0x818A	R	point 7 y coordinate (low byte)
0x818B	R	point 7 y coordinate (high byte)
0x818C	R	point 7 size (low byte)
0x818D	R	point 7 size (high byte)
0x818E	R	Reserved
0x818F	R	track id
0x8190	R	point 8 x coordinate (low byte)
0x8191	R	point 8 x coordinate (high byte)
0x8192	R	point 8 y coordinate (low byte)
0x8193	R	point 8 y coordinate (high byte)
0x8194	R	point 8 size (low byte)
0x8195	R	point 8 size (high byte)
0x8196	R	Reserved
0x8197	R	track id
0x8198	R	point 9 x coordinate (low byte)
0x8199	R	point 9 x coordinate (high byte)
0x819A	R	point 9 y coordinate (low byte)
0x819B	R	point 9 y coordinate (high byte)



0x819C	R	point 9 size (low byte)
0x819D	R	point 9 size (high byte)
0x819E	R	Reserved
0x819F	R	track id
0x81A0	R	point 10 x coordinate (low byte)
0x81A1	R	point 10 x coordinate (high byte)
0x81A2	R	point 10 y coordinate (low byte)
0x81A3	R	point 10 y coordinate (high byte)
0x81A4	R	point 10 size (low byte)
0x81A5	R	point 10 size (high byte)
0x81A6	R	Reserved
0x81A7	R	KeyValue

I2C protocol

3.3V ,400BPS ,pull high 2K ohm

Parameter	Symbol	Min.	Max.	Unit
SCL low period	t_{lo}	0.9	-	US
SCL high period	t_{hi}	0.8	-	US
SCL setup time for START condition	t_{st1}	0.4	-	US
SCL setup time for STOP condition	t_{st3}	0.4	-	US
SCL hold time for START condition	t_{hd1}	0.3	-	US
SDA setup time	t_{st2}	0.4	-	US
SDA hold time	t_{hd2}	0.4	-	US